

中央空调工程设计常见问题

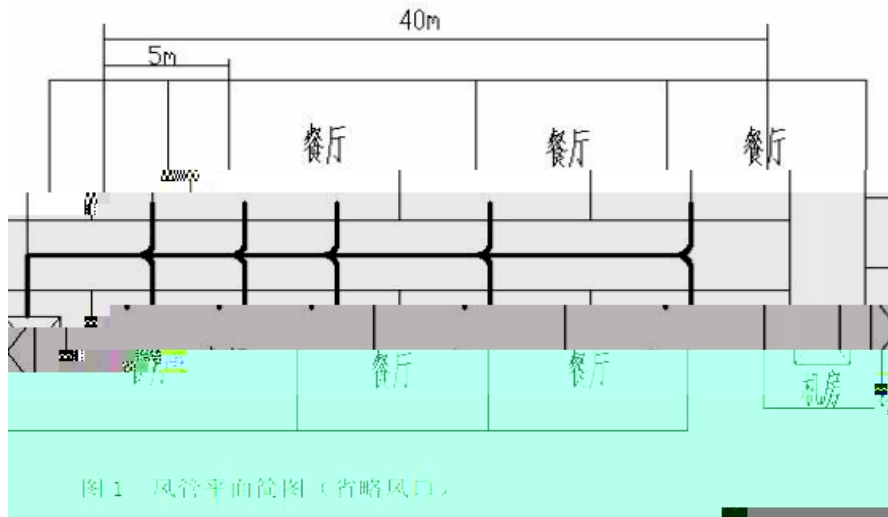



图2 吊顶回风的弊病

微信号: nhvacd



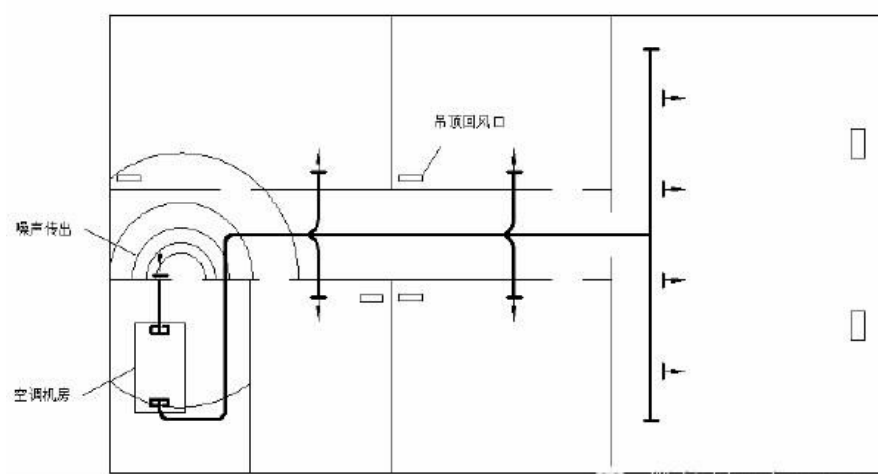

图2 吊顶回风立面图  微信号: nhvac



图 4 中间二次换热分区图 微信号: nhvac

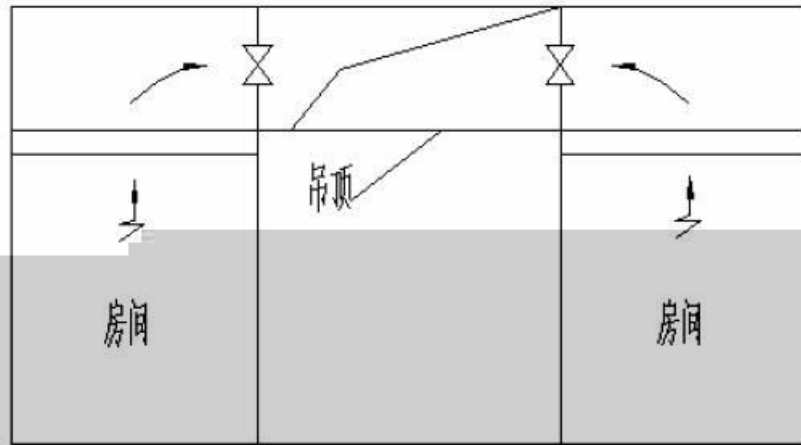

图 5 上下分别设置冷源示意图 微信号: nhvacca

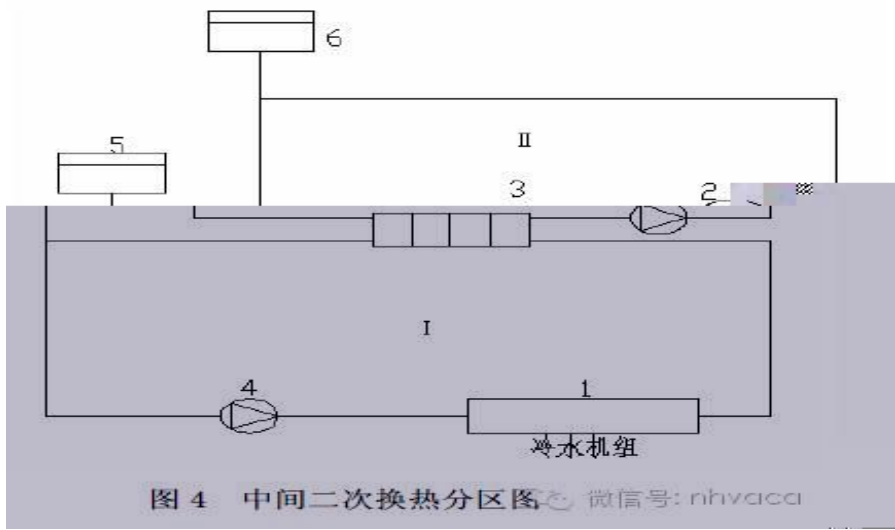

图 6 分设冷源分区示意图 微信号: nhvacca



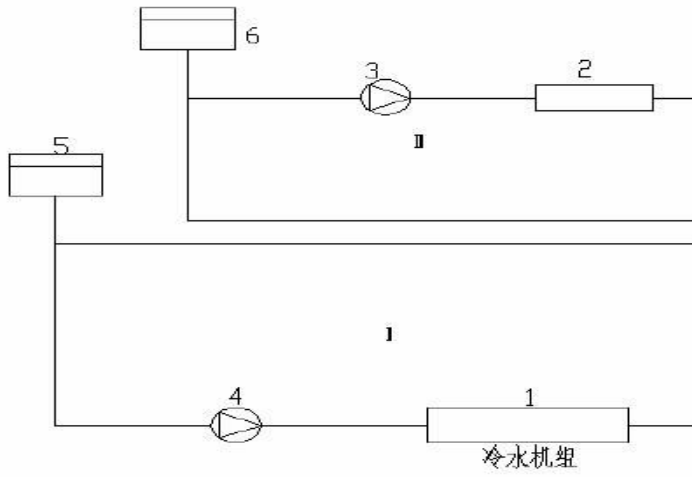

图 1

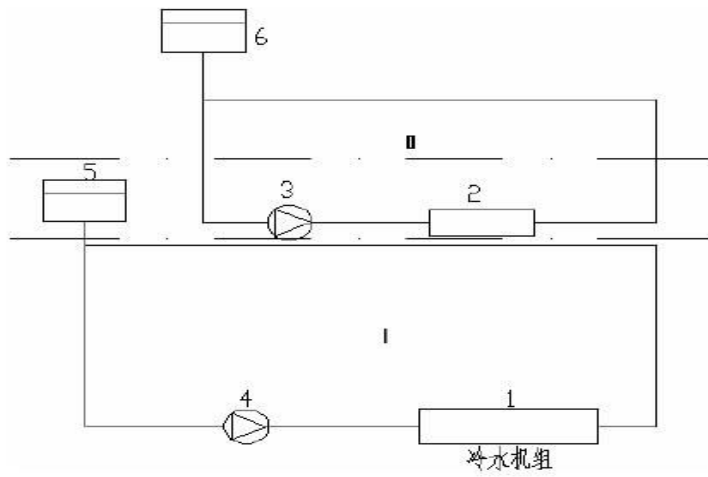
微信号: nhvac



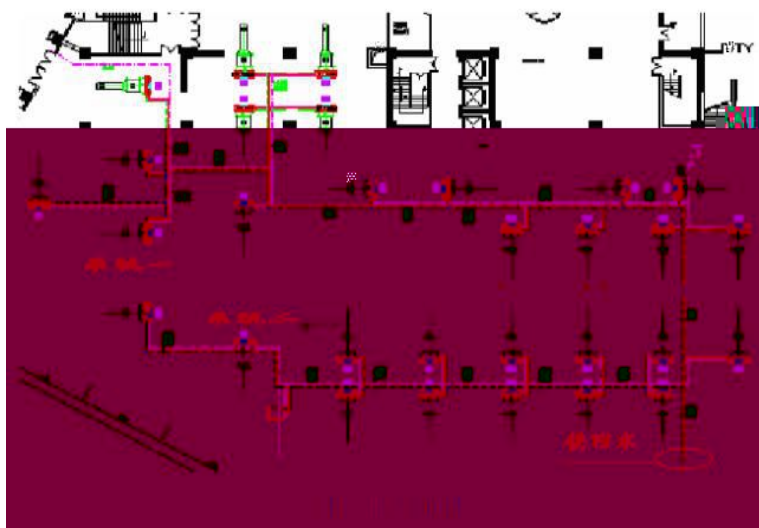
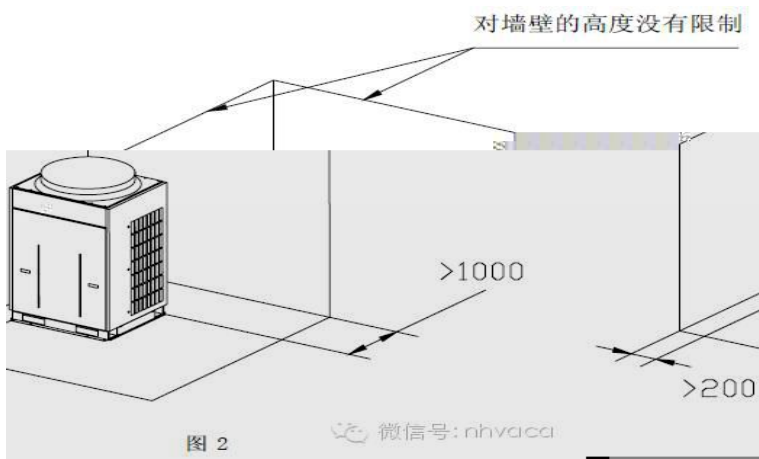
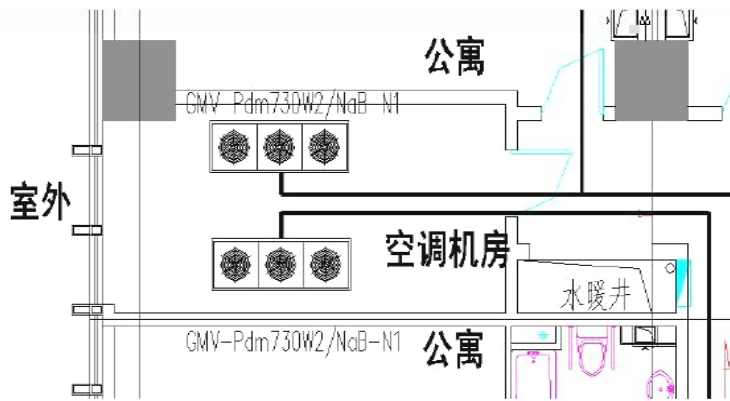

图 4 机组安装平面图 微信号: nnydca

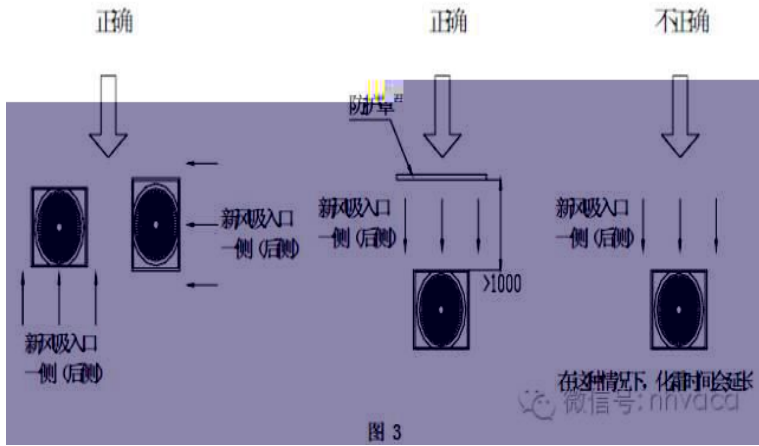